

# PRECISION PRESSURE REGULATOR

	DESCRIPTION	PRESSURE RANGE bar	CONNECTION thread	DEVICE	PAGE	
<b>WITH CONSTANT BLEED</b>	miniature	0.05 ... 2 / 8	G $\frac{1}{8}$ and flange	R90	<b>5.03</b>	
	proven	0.02 ... 0.5 / 10	G $\frac{1}{4}$	11-818	<b>5.06</b>	
	proven	0.14 ... 1.7 / 8	G $\frac{1}{4}$ and $\frac{1}{4}$ "NPT	53.10	<b>5.07</b>	
	very precise	0.01 ... 0.14 / 28	G $\frac{1}{4}$ - G $\frac{1}{2}$	10	<b>5.08</b>	
	many variations	0.01 ... 0.14 / 10	G $\frac{1}{4}$ - G $\frac{1}{2}$	R230	<b>5.09</b>	
	small design	0.001 ... 0.14 / 7	G $\frac{1}{4}$ and G $\frac{3}{8}$	R300	<b>5.10</b>	
	Nullmatic	0.002 ... 0.12 / 31	$\frac{1}{4}$ "NPT	R40	<b>5.12</b>	
	high exhaust	0.01 ... 3 / 10	G $\frac{1}{4}$ - G $\frac{1}{2}$	R03	<b>5.14</b>	
	low pressure	0.002 ... 0.35 / 0.8	G $\frac{1}{4}$ - G $\frac{1}{2}$	R110	<b>5.15</b>	
	2-stage	0.14 ... 2.7 / 8,2	G $\frac{1}{4}$ - G $\frac{3}{4}$	R700	<b>5.13</b>	
	many pressure areas	0.03 ... 0.15 / 14	G $\frac{1}{4}$ - G $\frac{3}{4}$	R410	<b>5.14</b>	
	non-relieving	0.03 ... 0.15 / 14	G $\frac{1}{4}$ - G $\frac{3}{4}$	R410-K	<b>5.14</b>	
	high volume flow	0.001 ... 0.7 / 10	G1 and G1 $\frac{1}{2}$	R102	<b>5.16</b>	
	miniature	0.01 ... 0.35 / 7	M5 and flange	RT	1.10	
	miniature	0.005 ... 0.05 / 1.5	G $\frac{1}{2}$	RR	3.10	
	clean room environment, SST	0.05 ... 2 / 4	G $\frac{1}{8}$ , M5	RE1	15.04	
	stainless steel	0.02 ... 1.5 / 10	G $\frac{1}{4}$ and G $\frac{1}{2}$	R3150	15.05	
	<b>WITHOUT CONSTANT BLEED</b>	robust	0.01 ... 0.5 / 16	G $\frac{1}{4}$	R217	<b>5.04</b>
		robust, low cost	0.01 ... 0.6 / 3.5	G $\frac{1}{4}$ and G $\frac{3}{8}$	R216	<b>5.05</b>
		non-relieving	0.01 ... 0.14 / 28	G $\frac{1}{4}$ - G $\frac{1}{2}$	10-N	<b>5.08</b>
non-relieving		0.01 ... 0.14 / 10	G $\frac{1}{4}$ - G $\frac{1}{2}$	R230-K	<b>5.09</b>	
small design		0.001 ... 0.14 / 7	G $\frac{1}{4}$ and G $\frac{3}{8}$	R300-K	<b>5.10</b>	
high volume flow		0.03 ... 0.7 / 10	G $\frac{1}{4}$ and G $\frac{3}{8}$	R100	<b>5.11</b>	
high-precision		0.03 ... 0.7 / 17	G $\frac{3}{8}$ - G $\frac{3}{4}$	R400	<b>5.13</b>	
non-relieving		0.002 ... 0.35 / 0.8	G $\frac{1}{4}$ - G $\frac{1}{2}$	R110-K	<b>5.15</b>	
non-relieving		0.001 ... 0.7 / 10	G1 and G1 $\frac{1}{2}$	R102-K	<b>5.16</b>	
differential pressure regulator		0.01 ... 1 / 10	G $\frac{1}{4}$ and G $\frac{3}{8}$	R650	6.02	
miniature		0.2 ... 2 / 9	flange	R342	1.14	
miniature		0.2 ... 2 / 9	G $\frac{1}{8}$ and G $\frac{1}{4}$	R344	1.14	
miniature		0.1 ... 3 / 6	G $\frac{1}{8}$	R309	1.16	
miniature		0.2 ... 2.5 / 8	G $\frac{1}{8}$	R307	1.18	
miniature		0.2 ... 0.25 / 8	flange	R308	1.19	



# 5

Precision



5

**Description** Diaphragm precision pressure regulator of very small design and low air consumption compressed air or non-corrosive gases

**Media** max. 10 bar

**Supply pressure** response sensitivity:  $\pm 0.2\%$  FS

**Accuracy** repeatability:  $\pm 0.3\%$  FS

**Air consumption** supply sensitivity: 35 mbar for a 7 bar supply pressure change

**Adjustment** max. 3 l/min at 10 bar supply pressure. Consumption depends on supply pressure.

**Relieving function** by handwheel with locknut

**Gauge port** relieving

**Mounting position** G $\frac{1}{8}$  on both sides of the body, screw plug supplied

**Temperature range** any

**Material** 10 °C to 70 °C / 50 °F to 158 °F

Body: zinc die-cast  
Elastomer: NBR/Buna-N  
Inner valve: stainless steel and brass

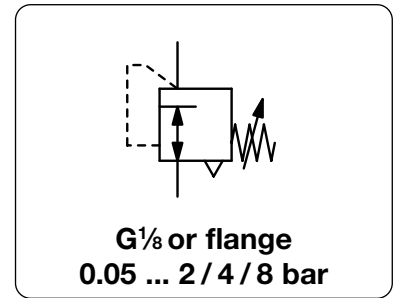

Dimensions			Flow rate	Supply pressure	Connection thread	Pressure range	Order number
A	B	C	l/min*1	max. bar	G / flange	bar	

Precision pressure regulator							supply pressure max. 10 bar, relieving, with constant bleed	R90
35	94	10	200	10	G $\frac{1}{8}$	0.05...2		R90-01A
						0.08...4		R90-01B
						0.10...8		R90-01C



R90

Precision pressure regulator with flange							supply pressure max. 10 bar, relieving, with constant bleed	R90-P
35	106	12	200	10	Flansch	0.05...2		R90-P1A
						0.08...4		R90-P1B
						0.10...8		R90-P1C

## Accessories, enclosed

pressure gauge	$\varnothing$ 23 mm, 0...*2 bar, G $\frac{1}{8}$	MA2301-...*2
mounting bracket	made of steel, mounting nut at the device	BW10-02

Precision



5

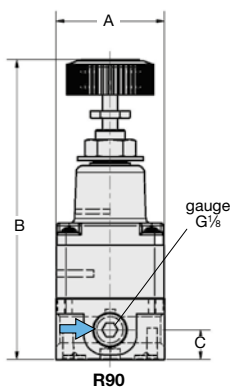

R90

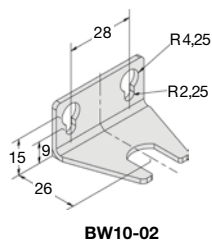

BW10-02

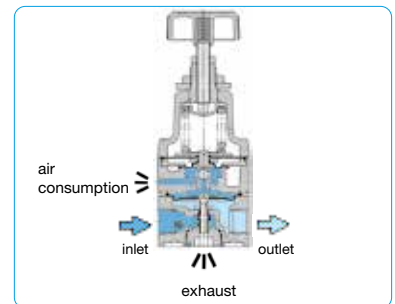

cross-section

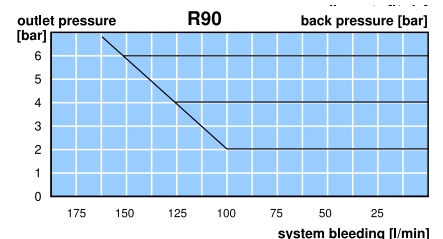
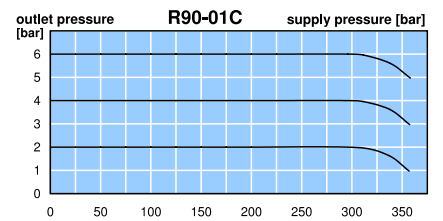

\*1 for compressed air : 7 bar supply pressure, 6 bar outlet pressure and 1 bar pressure drop  
\*2 04 = 0...4 bar, 10 = 0...10 bar

Gauges: see chapter for measuring devices

PDF CAD  
www.aircom.net



Order example:  
R90-01A

# PRECISION PRESSURE REGULATOR

11-818

<b>Description</b>	Precision pressure regulator designed for precise pressure control in the event of changes in flow and supply pressure. Due to constant bleed slight blow-off sounds existing.	
<b>Media</b>	dry, oil-free and 25 µm filtered compressed air	
<b>Supply pressure</b>	max. 8 bar for 0.02...0.5 bar, max. 10 bar for 0.07...4 bar, max. 14 bar for 0.4...10 bar	
<b>Accuracy</b>	at varying supply pressures: < 20 mbar pressure deviation at varying volume flows: < 30 mbar pressure deviation at 5 °C / K temperature variation: < 3 mbar pressure deviation	
<b>Air consumption</b>	max. 2 l/min, subject to outlet pressure	
<b>Adjustment</b>	by handwheel for panel mounting, optionally by spindle	
<b>Relieving function</b>	relieving, 3 mm exhaust diameter	
<b>Gauge port</b>	G¼ on both sides of the body, optionally without gauge port	<b>Mounting position</b> any
<b>Temperature range</b>	0 °C to 70 °C / 32 °F to 158 °F, for appropriately conditioned compressed air down to -30 °C / -22 °F	
<b>Material</b>	Body: zinc die-cast Elastomer: NBR/Buna-N	Inner valve: brass, plastic

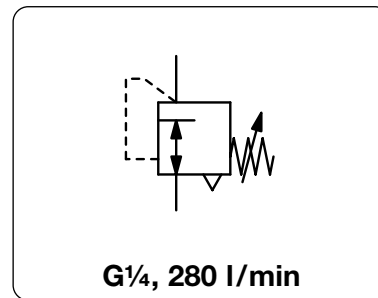

Dimensions			Description	P <sub>1</sub> max.	Flow rate	Connection thread	Pressure range	Order number
A	B	C						
mm	mm	mm		bar	l/min*1	G	bar	

Precision pressure regulator			P1: max. 8 / 10 / 14 bar, relieving, with constant bleed, accuracy < 30 mbar, K <sub>v</sub> = 0.16 m³/h					11-818
55	137	13	handwheel w/o gauge port	8	280	G¼	0.02 ... 0.5	11-818-999
				10			0.07 ... 4.0	11-818-100
				14			0.40 ... 10	11-818-110
55	137	13	handwheel with gauge port	8	280	G¼	0.02 ... 0.5	11-818-987
				10			0.07 ... 4.0	11-818-993
				14			0.40 ... 10	11-818-991
55	137	13	spindle w/o gauge port	8	280	G¼	0.02 ... 0.5	11-818-998
				10			0.07 ... 4.0	11-818-101
				14			0.40 ... 10	11-818-112



## Special options, add the appropriate letter

**tamper-proof cap** made of brass, adjustment by screwdriver, total height 108 mm 11-818-...T

## Accessories, enclosed

<b>pressure gauge</b>	Ø 50 mm, 0...*2 bar, G¼	MA5002-...*2
<b>mounting bracket</b>	made of steel, mounting nut at the device	BW12-01
<b>tamper-proof cap</b>	for metal sheet thickness from 2.5 up to 6 mm	3081-01

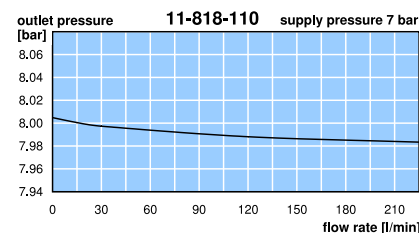
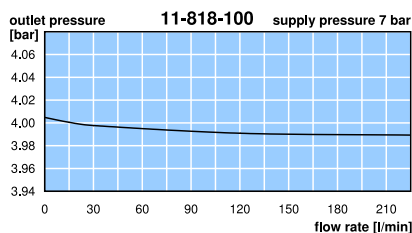
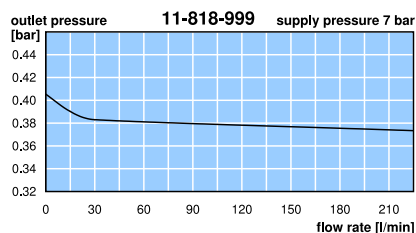
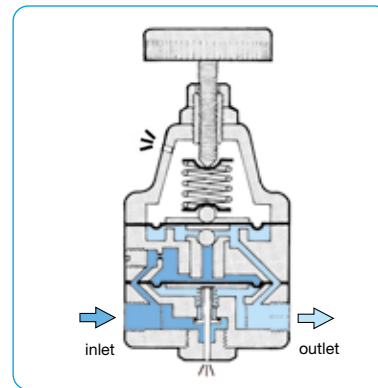
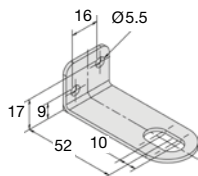
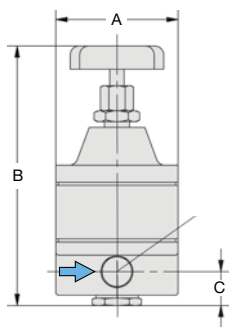
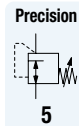

\*1 at 7 bar supply pressure and 1.4 bar outlet pressure

\*2 01 = 0...1 bar, 04 = 0...4 bar, 10 = 0...10 bar

Gauges: see chapter for measuring devices

PDF CAD  
www.aircom.net



Order example:  
11-818-999

<b>Description</b>	Regulator of proven reliability and durability designed for precise pressure regulation in the event of changes in flow, supply pressure and temperature. Slight exhaust sounds are normal.	
<b>Note</b>	To avoid leaks the mounting nut must be screwed tight.	
<b>Media</b>	dry, oil-free and 25 µm filtered compressed air	
<b>Supply pressure</b>	max. 10 bar	
<b>Accuracy</b>	at varying supply pressures: < 1 mbar pressure deviation at varying volume flows: < 5 mbar pressure deviation	
<b>Air consumption</b>	max. 2 l/min, subject to outlet pressure	
<b>Adjustment</b>	by handwheel with locknut, for panel mounting	<b>Mounting position</b> any
<b>Relieving function</b>	relieving, the exhaust valve's diameter is six times greater than the regulating valve's diameter	
<b>Gauge port</b>	G¼ or ¼" NPT on both sides of the body, identical with the connection thread	
<b>Temperature range</b>	0 °C to 70 °C / 32 °F to 158 °F, for appropriately conditioned compressed air down to -30 °C / -22 °F	
<b>Material</b>	Body: zinc die-cast Elastomer: NBR/Buna-N	Measuring capsule: beryllium copper

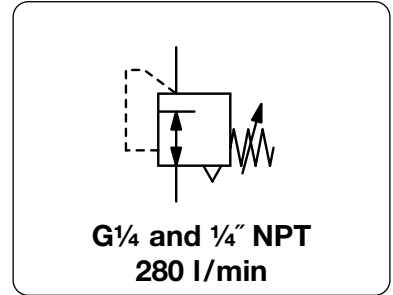

Dimensions			Description	K <sub>v</sub> -value	Flow rate	Connection thread	Pressure range	Order number
A	B	C						
mm	mm	mm		(m³/h)	m³/h*1 l/min*1	G/NPT	bar	

Precision pressure regulator			supply pressure max. 10 bar, relieving, with constant bleed, accuracy 5 mbar				Manostat		
54	70	14	standard	0.16	17	280	G¼	0.14 ... 1.7	<b>53.1002.4X</b>
								0.14 ... 4.0	<b>53.1002.5X</b>
								0.14 ... 8.0	<b>53.1002.6X</b>
54	70	14	standard	0.16	17	280	¼" NPT	0.14 ... 1.7	<b>53.1002.00</b>
								0.14 ... 4.0	<b>53.1003.00</b>
								0.14 ... 8.0	<b>53.1004.00</b>



53.1002.6X

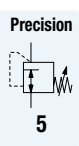

## Special options, add the appropriate letter

**tamper-proof cap** aluminium, adjustment by screwdriver, total height 109 mm 53.1. .... T

## Accessories, enclosed

**pressure gauge** Ø 50 mm, 0 ... \*2 bar, G¼ **MA5002-...\*2**  
**connecting parts gauge** for NPT ports, adapter ¼" NPT - G¼ female **VP-0202N**  
**mounting bracket** made of steel, mounting nut at the device **BW11-01**

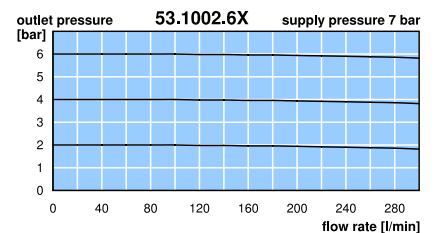
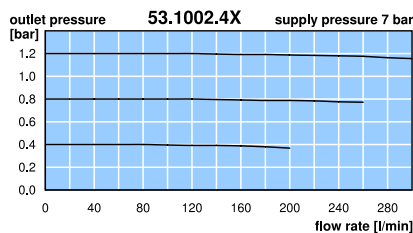
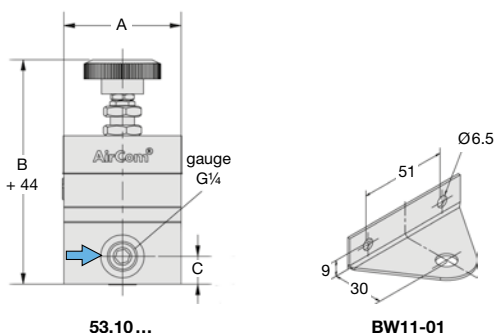
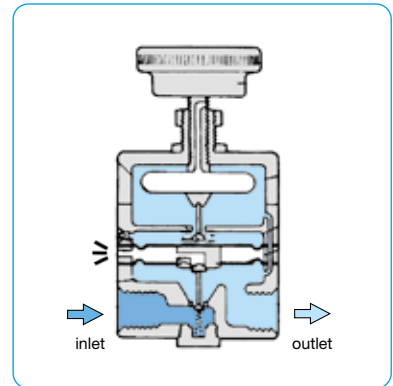

\*1 at 7 bar supply pressure and 1.4 bar outlet pressure  
 \*2 02 = 0...2.5 bar, 04 = 0...4 bar, 10 = 0...10 bar

Gauges: see chapter for measuring devices

PDF CAD  
www.aircom.net

Order example:  
**53.1002.4X**

# PRECISION REGULATOR WITHOUT CONSTANT BLEED, UP TO 3.5 BAR OUTLET PRESSURE R216

<b>Description</b>	Diaphragm pressure regulator with good regulation accuracy at varying volume flow, especially at low pressure.		
<b>Media</b>	compressed air or non-corrosive gases		
<b>Supply pressure</b>	max. 21 bar		
<b>Accuracy</b>	response sensitivity: < 100 mbar		
<b>Air consumption</b>	without constant bleed		
<b>Adjustment</b>	by T-handle with locknut, mounting bracket not possible by handwheel, suitable for panel mounting		
<b>Relieving function</b>	relieving, optionally non-relieving		
<b>Gauge port</b>	G $\frac{3}{8}$ on the bottom side of the body, one screw plug supplied		
<b>Mounting position</b>	any		
<b>Temperature range</b>	0 °C to 50 °C / 32 °F to 122 °F for handwheel version 0 °C to 80 °C / 32 °F to 176 °F for T-handle version		
<b>Material</b>	Body: zinc die-cast	Elastomer: NBR/Buna-N	Bottom screw: brass

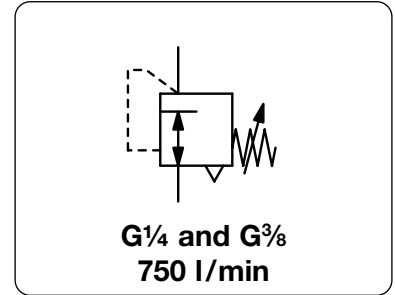

Dimensions			Adjustment	Kv-value	Flow rate		Connection thread	Pressure range	Order number
A	B	C	by	(m <sup>3</sup> /h)	m <sup>3</sup> /h*1	l/min*1	G	bar	

Precision pressure regulator									
supply pressure max. 21 bar, relieving, without constant bleed									
108	162	32	<b>T-handle</b>	0.39	42	700	G $\frac{1}{4}$	0.01 ... 0.6	<b>R216-02E</b>
								0.01 ... 1.6	<b>R216-02F</b>
								0.01 ... 3.5	<b>R216-02H</b>
				0.42	45	750	G $\frac{3}{8}$	0.01 ... 0.6	<b>R216-03E</b>
								0.01 ... 1.6	<b>R216-03F</b>
								0.01 ... 3.5	<b>R216-03H</b>
108	162	32	<b>handwheel</b>	0.39	42	700	G $\frac{1}{4}$	0.01 ... 0.6	<b>R216-02EP</b>
			for panel mounting					0.01 ... 1.6	<b>R216-02FP</b>
								0.01 ... 3.5	<b>R216-02HP</b>
				0.42	45	750	G $\frac{3}{8}$	0.01 ... 0.6	<b>R216-03EP</b>
								0.01 ... 1.6	<b>R216-03FP</b>
								0.01 ... 3.5	<b>R216-03HP</b>



R216-02F



R216-03FP for panel mounting

## Special options, add the appropriate letter

<b>non-relieving</b>	without relieving function	R216-0...K
<b>NPT</b>	connection thread	R216-0...N
<b>free of oil and grease</b>	specially cleaned	R216-0...L

## Accessories, enclosed

<b>pressure gauge</b>	Ø 63 mm, 0... <sup>2</sup> bar, G $\frac{1}{4}$ , connection parts required	<b>MA6302-...<sup>2</sup></b>
<b>connection parts</b>	for pressure gauge	<b>AM-02</b>
<b>mounting bracket</b>	made of steel, mounting nut at the device for R216-0...P	<b>BW20-02</b>

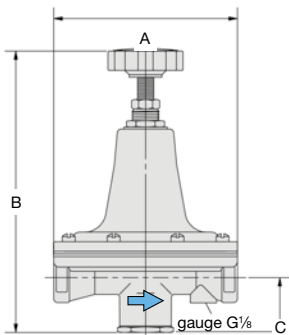

R216-...P

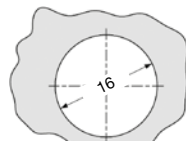

panel cut-out

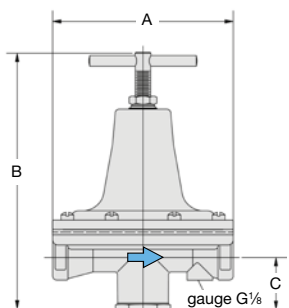

R216

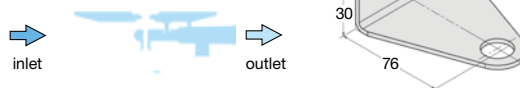

cross-section

BW20-02

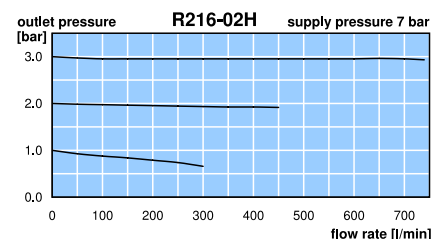
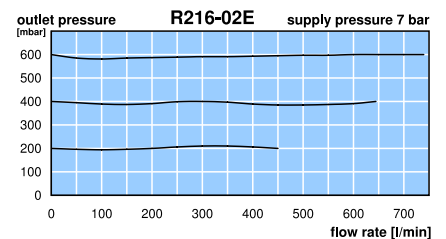

\*1 at 7 bar supply pressure and 3 bar outlet pressure

\*2 01 = 0...1 bar, 02 = 0...2.5 bar, 04 = 0...4 bar

<b>Description</b>	The diaphragm pressure regulator provides precision regulation in high flow applications. A balanced inner valve, sensitive rolling diaphragm and carefully positioned aspirator tube ensure constant outlet pressure even with changing supply pressure and flow fluctuations.	
<b>Media</b>	compressed air or non-corrosive gases	
<b>Supply pressure</b>	max. 17 bar	
<b>Accuracy</b>	response sensitivity: < 4 mbar	
<b>Air consumption</b>	max. 6 l/min, subject to outlet pressure	
<b>Adjustment</b>	by handwheel with locknut	
<b>Relieving function</b>	relieving, optionally non-relieving	
<b>Relief capacity</b>	110 l/min at 1.5 bar outlet and 0.35 bar overpressure above setpoint	
<b>Gauge port</b>	G $\frac{1}{4}$ on both sides of the body, optionally $\frac{1}{4}$ " NPT	
<b>Temperature range</b>	0 °C to 80 °C / 32 °F to 176 °F, for appropriately conditioned compressed air down to -40 °C / -40 °F	
<b>Material</b>	Body: aluminium die-cast Elastomer: NBR/Buna-N	Mounting position any Inner valve: stainless steel and brass

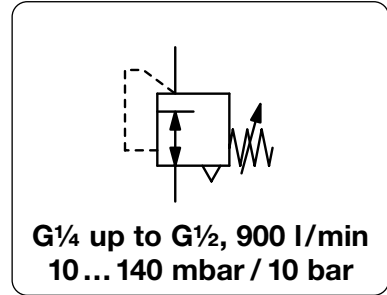

Dimensions			K <sub>v</sub> -value (m <sup>3</sup> /h)	Flow rate m <sup>3</sup> /h*1 l/min*1	Connection thread G	Pressure range bar	Order number
A	B	C					

Precision pressure regulator							supply pressure max. 17 bar, relieving, with constant bleed	R230
67	154	16	0.5	54	900	G $\frac{1}{4}$	0.01 ... 0.14	R230-020
							0.01 ... 1.0	R230-02A
							0.01 ... 2.0	R230-02B
							0.07 ... 4.0	R230-02C
							0.14 ... 10	R230-02D



**Special options, add the appropriate letter**

G $\frac{3}{8}$	connection thread	R230-03 .
G $\frac{1}{2}$	connection thread, recommended for mbar range	R230-04 .
NPT	connection thread	R230-0 . .N
non-relieving	and without constant bleed	R230-0 . .K
reduced bleeding		R230-0 . .X19
tapped exhaust	connection thread G $\frac{1}{4}$	R230-0 . .X12
tamper-proof cap	aluminium, adjustment by screwdriver, total height 157 mm	R230-0 . .T
check valve	quick exhaust at supply pressure removal	R230-0 . .X80

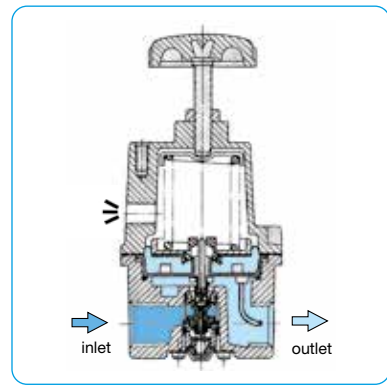

**Accessories, enclosed**

pressure gauge	Ø 63 mm, 0...160 mbar, G $\frac{1}{4}$ , capsule type	MA6302-C2
pressure gauge	Ø 50 mm, 0...*2 bar, G $\frac{1}{4}$ , Bourdon tube	MA5002-...*2
gauge connectors	NPT connection thread, adapter $\frac{1}{4}$ " NPT to G $\frac{1}{4}$ female	VP-0202N
mounting bracket	made of steel	BW00-33

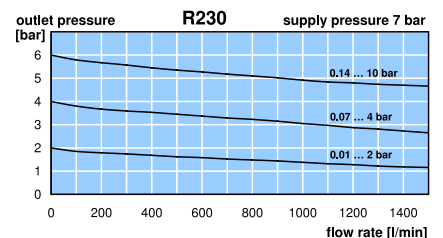
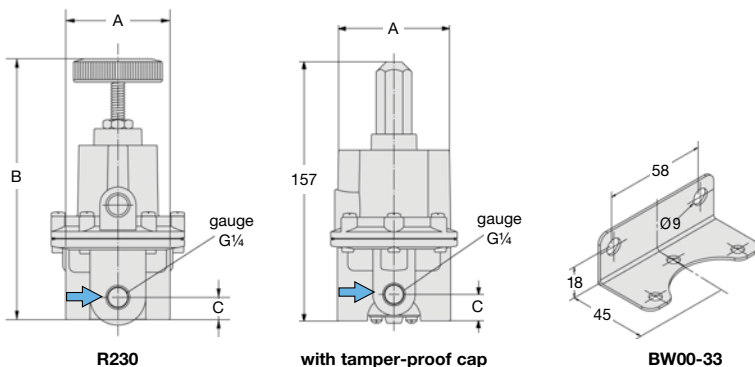

\*1 at 7 bar supply pressure, 6 bar outlet pressure and 1 bar pressure drop  
\*2 01 = 0...1 bar, 02 = 0...2.5 bar, 06 = 0...6 bar, 10 = 0...10 bar

<b>Description</b>	The diaphragm pressure regulator provides precision regulation in high flow applications. A balanced inner valve, sensitive rolling diaphragm and carefully positioned aspirator tube ensure constant outlet pressure even with changing supply pressure and flow fluctuations.	
<b>Media</b>	compressed air or non-corrosive gases	
<b>Supply pressure</b>	max. 35 bar	
<b>Accuracy</b>	response sensitivity: < 2 mbar	
<b>Air consumption</b>	max. 6 l/min, subject to outlet pressure	
<b>Adjustment</b>	by handwheel with locknut	
<b>Relieving function</b>	relieving, optionally non-relieving	
<b>Relief capacity</b>	150 l/min at 1.5 bar outlet and 0.35 bar overpressure above setpoint	
<b>Gauge port</b>	G $\frac{1}{4}$ on both sides of the body, optionally $\frac{1}{4}$ " NPT	
<b>Temperature range</b>	0 °C to 90 °C / 32 °F to 194 °F, for appropriately conditioned compressed air down to -40 °C / -40 °F	
<b>Material</b>	Body: aluminium die-cast	Inner valve: stainless steel and brass
	Elastomer: NBR/Buna-N, optionally FKM	

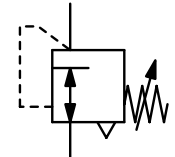

**G $\frac{1}{4}$  up to G $\frac{1}{2}$ , 1000 l/min  
10 ... 140 mbar / 28 bar**

Dimensions			K <sub>v</sub> -value (m <sup>3</sup> /h)	Flow rate m <sup>3</sup> /h*1 l/min*1	Connection thread G	Pressure range bar	Order number *
A	B	C					

Precision pressure regulator							supply pressure max. 35 bar, relieving, with constant bleed	Model 10
67	169	26	0.64	60	1000	G $\frac{1}{4}$	0.01 ... 0.14	<b>10212H</b>
							0.01 ... 0.7	<b>10222H</b>
							0.01 ... 1.4	<b>10202H</b>
							0.01 ... 2.1	<b>10232H</b>
							0.07 ... 4.1	<b>10242H</b>
							0.14 ... 10	<b>10262H</b>
							0.20 ... 14	<b>10272H</b>
67	178	26	0.64	60	1000	G $\frac{1}{4}$	0.30 ... 21	<b>10282H</b>
							0.30 ... 28	<b>10292H</b>

**Special options,** add the appropriate letter

<b>G<math>\frac{3}{8}</math></b>	connection thread	102.3H
<b>G<math>\frac{1}{2}</math></b>	connection thread, recommended for mbar-range	102.4H
<b>NPT</b>	connection thread	102.2
<b>non-relieving</b>	and without constant bleed	102.2.N
<b>reduced bleeding</b>	approx. 2 l/min	102.2.B
<b>for small flow rate</b>	high constant bleed for more sensitivity	102.2.L
<b>tapped exhaust</b>	G $\frac{1}{4}$ connection thread	102.2.E
<b>FKM elastomer</b>		102.2.J
<b>tamper-proof cap</b>	aluminium, adjustment by screwdriver, total height 166 mm	102.2.T
<b>for oxygen</b>	specially cleaned	102.2.SC
<b>non-ferrous metal-free</b>	FKM elastomer	102.2.X63

**Accessories,** enclosed

<b>pressure gauge</b>	Ø 63 mm, 0 ... 160 mbar, G $\frac{1}{4}$ , capsule type	<b>MA6302-C2</b>
<b>pressure gauge</b>	Ø 50 mm, 0 ... *2 bar, G $\frac{1}{4}$ , Bourdon tube	<b>MA5002-...*2</b>
<b>gauge connectors</b>	for NPT ports, adapter $\frac{1}{4}$ " NPT - G $\frac{1}{4}$ female	<b>VP-0202N</b>
<b>mounting bracket</b>	made of steel	<b>BW00-34</b>

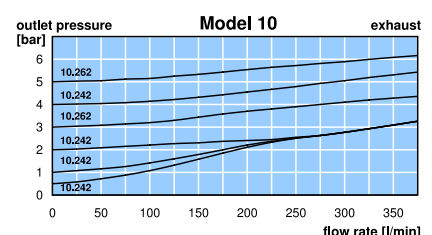
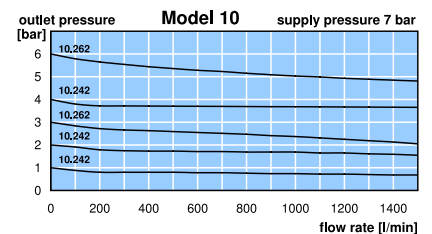
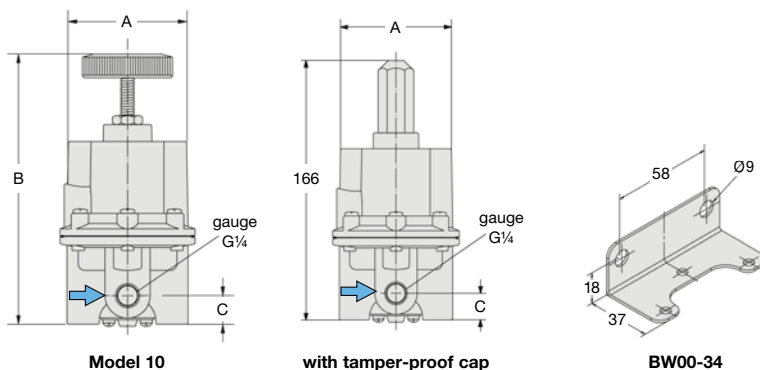
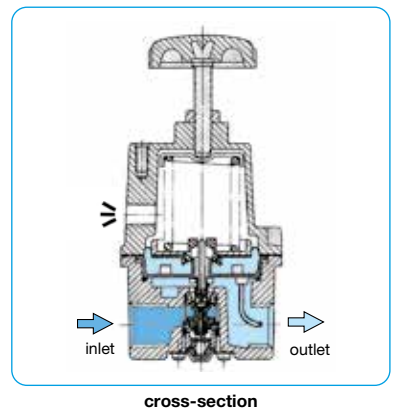

\*1 at 7 bar supply pressure, 6 bar outlet pressure and 1 bar pressure drop  
\*2 01 = 0 ... 1 bar, 02 = 0 ... 2.5 bar, 06 = 0 ... 6 bar, 10 = 0 ... 10 bar, 16 = 0 ... 16 bar, 25 = 0 ... 25 bar, 60 = 0 ... 60 bar

Gauges: see chapter for measuring devices

PDF CAD  
www.aircom.net

 **Order example:  
10212H**

<b>Description</b>	Diaphragm pressure regulator of small and lightweight design with high flow capacity. It provides sensitive adjustment accurate to 2 mbar.	
<b>Media</b>	compressed air or non-corrosive gases	
<b>Supply pressure</b>	max. 18 bar	
<b>Accuracy</b>	setting accuracy:	< 2 mbar
	response sensitivity:	< 2 mbar
<b>Air consumption</b>	max. 3 l/min, subject to outlet pressure	
<b>Adjustment</b>	by handwheel with locknut	
<b>Relieving function</b>	relieving	
<b>Relief capacity</b>	55 l/min at 1.5 bar outlet and 0.35 bar overpressure above setpoint	
<b>Gauge port</b>	G $\frac{1}{8}$ on both sides of the body, screw plugs supplied	
<b>Temperature range</b>	0 °C to 90 °C / 32 °F to 194 °F, for appropriately conditioned compressed air down to -40 °C / -40 °F	
<b>Material</b>	Body:	aluminium die-cast
	Inner valve:	stainless steel, brass and steel
	Elastomer:	NBR/Buna-N, optionally FKM

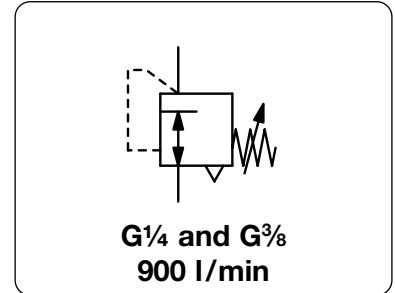

Dimensions			K <sub>v</sub> -value (m <sup>3</sup> /h)	Flow rate m <sup>3</sup> /h*1 l/min*1	Connection thread G	Pressure range bar	Order number
A	B	C					

Precision pressure regulator							supply pressure max. 18 bar, relieving with constant bleed	R300
57	133	25	0.5	54	900	G $\frac{1}{4}$	0.001 ... 0.14	<b>R300-020</b>
							0.01 ... 0.7	<b>R300-021</b>
							0.03 ... 2.0	<b>R300-02A</b>
							0.07 ... 4.0	<b>R300-02B</b>
							0.14 ... 7.0	<b>R300-02C</b>
57	133	25	0.5	54	900	G $\frac{3}{8}$	0.001 ... 0.14	<b>R300-030</b>
							0.01 ... 0.7	<b>R300-031</b>
							0.03 ... 2.0	<b>R300-03A</b>
							0.07 ... 4.0	<b>R300-03B</b>
							0.14 ... 7.0	<b>R300-03C</b>



R300

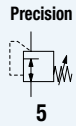

## Special options, add the appropriate letter

<b>without constant bleed</b>	non-relieving, for small flow rate	R300-0...K
<b>NPT</b>	connection thread	R300-0...N
<b>tamper-proof cap</b>	aluminium, adjustment by screwdriver, total height 141 mm	R300-0...T
<b>FKM elastomer</b>		R300-0...V
<b>for oxygen</b>	specialy cleaned, with oxygen grease	R300-0...K15

## Accessories, enclosed

<b>pressure gauge</b>	Ø 63 mm, 0... 160 mbar, G $\frac{1}{4}$ -connection parts required	<b>MA6302-C2</b>
<b>pressure gauge</b>	Ø 50 mm, 0...*2 bar, G $\frac{1}{8}$	<b>MA5001-...*2</b>
<b>gauge connection parts</b>	for MA6302-C2	<b>AM-04</b>
<b>mounting bracket</b>	made of steel	<b>BW00-46</b>

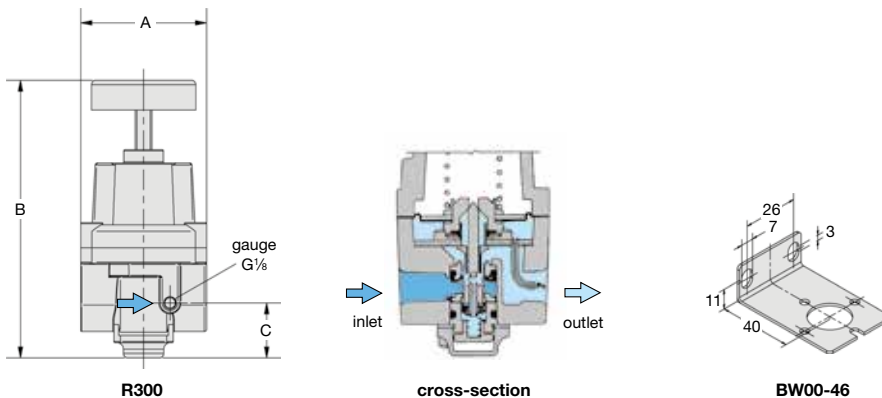
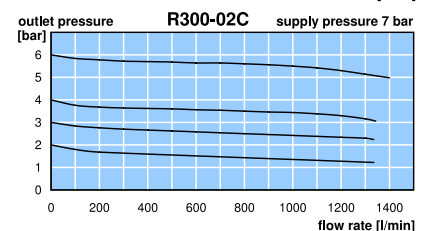
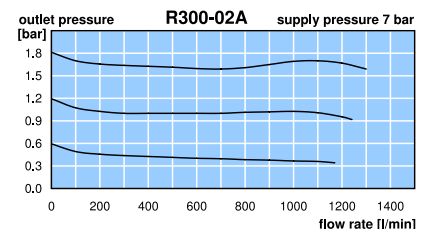
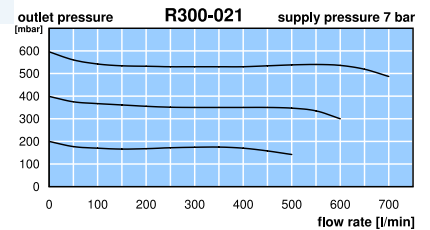
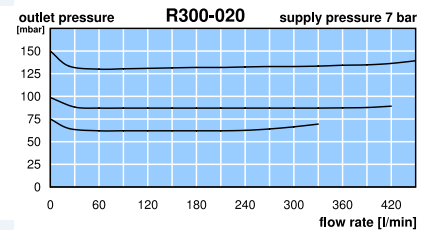

\*1 at 7 bar supply pressure and 1.4 bar outlet pressure  
\*2 01 = 0...1 bar, 02 = 0...2.5 bar, 04 = 0...4 bar, 10 = 0...10 bar, 16 = 0...16 bar, C2 = 160 mbar

Gauges: see chapter for measuring devices

PDF CAD  
www.aircom.net

Order example:  
R300-020



# PRECISION PRESSURE REGULATOR WITHOUT CONSTANT BLEED

R100

<b>Description</b>	Regulator provides precision regulation in high flow and high relief applications. A sensitive rolling diaphragm and balanced inner valve assure constant outlet pressure even with changing supply pressure and flow fluctuations.	
<b>Media</b>	compressed air or non-corrosive gases	
<b>Supply pressure</b>	max. 18 bar	
<b>Accuracy</b>	at supply pressure variation of 7 bar: < 7 mbar pressure deviation response sensitivity: < 2 mbar	
<b>Air consumption</b>	without constant bleed	
<b>Adjustment</b>	by handwheel with locknut	
<b>Relieving function</b>	relieving	
<b>Relief capacity</b>	200 l/min at 1.5 bar outlet and 0.35 bar overpressure above setpoint	
<b>Gauge port</b>	G $\frac{1}{4}$ on both sides of the body, screw plugs supplied	
<b>Temperature range</b>	0 °C to 80 °C / 32 °F to 194 °F, for appropriately conditioned compressed air down to -40 °C / -40 °F	
<b>Material</b>	Body: zinc die-cast    Inner valve: aluminium, brass and neoprene	<b>Mounting position</b> any Elastomer: NBR/Buna-N

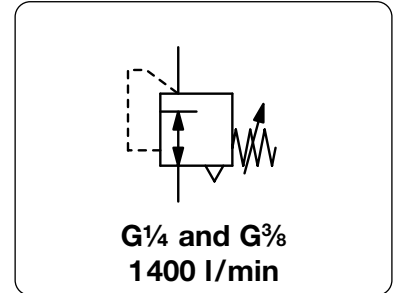

Dimensions			K <sub>v</sub> -value (m <sup>3</sup> /h)	Flow rate		Connection thread G	Pressure range bar	Order number
A	B	C		m <sup>3</sup> /h*1	l/min*1			

Precision pressure regulator							supply pressure max. 18 bar, relieving, without constant bleed	R100
54	129	25	0.73	78	1300	G $\frac{1}{4}$	0.03 ... 0.7	R100-021
							0.03 ... 2.0	R100-02A
							0.07 ... 4.0	R100-02B
							0.14 ... 10	R100-02C
54	129	25	0.78	84	1400	G $\frac{3}{8}$	0.03 ... 0.7	R100-031
							0.03 ... 2.0	R100-03A
							0.07 ... 4.0	R100-03B
							0.14 ... 10	R100-03C



R100

## Special options, add the appropriate letter

<b>NPT</b>	connection thread	R100-0. . N
<b>tamper-proof cap</b>	of aluminium, adjustment by screwdriver, total height 139 mm	R100-0. . T

## Accessories, enclosed

<b>pressure gauge</b>	Ø 50 mm, 0...*2 bar, G $\frac{1}{4}$	MA5002- . . *2
<b>mounting bracket</b>	made of steel	BW20-04

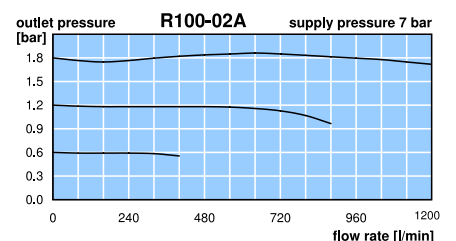
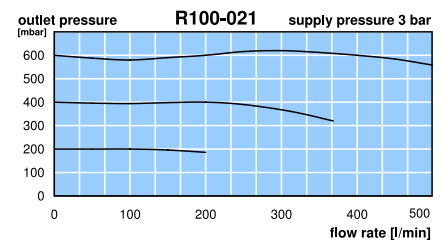
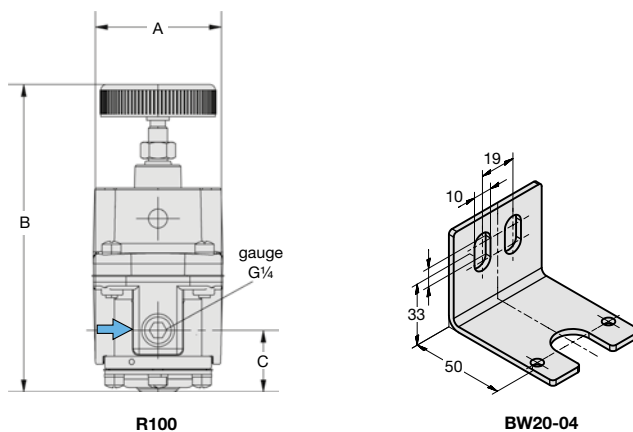
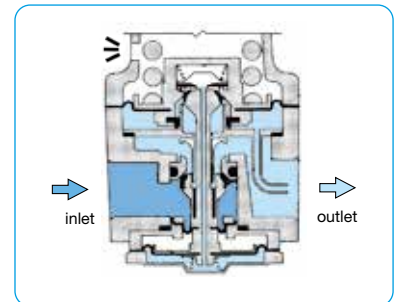
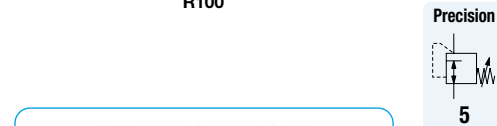

\*1 at 7 bar supply pressure and 1.4 bar outlet pressure  
\*2 01 = 0...1 bar, 02 = 0...2.5 bar, 04 = 0...4 bar, 10 = 0...10 bar

Gauges: see chapter for measuring devices

PDF CAD  
www.aircom.net

Order example:  
R100-021

<b>Description</b>	Regulator provides precision regulation in high flow and high relief applications. A sensitive rolling diaphragm and balanced inner valve ensure constant outlet pressure even with changing supply pressure and flow fluctuations. The regulator is silicone-free and suitable for panel mounting.	
<b>Media</b>	oil-free and 5 µm filtered compressed air or non-corrosive gases	
<b>Supply pressure</b>	max. 16 bar	
<b>Accuracy</b>	at supply pressure change from 2 bar to 7 bar: < 6 mbar pressure deviation at volume flow change from 0 l/min to 20 l/min: < 20 mbar pressure deviation response sensitivity: < 4 mbar	
<b>Air consumption</b>	< 1.5 l/min at P <sub>i</sub> = 5 bar, < 2 l/min at P <sub>i</sub> = 7 bar, < 4 l/min at P <sub>i</sub> = 10 bar, < 1% of volume flow	
<b>Adjustment</b>	by handwheel with locknut, suitable for panel mounting	
<b>Relieving function</b>	relieving	
<b>Relief capacity</b>	700 l/min at 6 bar outlet and 0.35 bar overpressure above setpoint	
<b>Gauge port</b>	G¼ on both sides of the body, one screw plug supplied	
<b>Temperature range</b>	0 °C to 60 °C / 32 °F to 140 °F, for appropriately conditioned compressed air down to -35 °C / -31 °F	
<b>Material</b>	Body: zinc die-cast Elastomer: NBR/Buna-N	

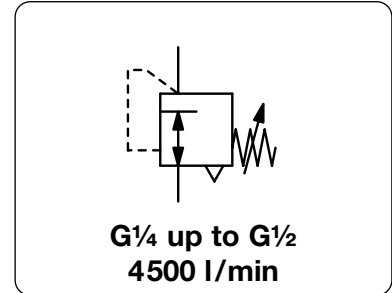

Dimensions			K <sub>v</sub> -value (m³/h)	Flow rate		Connection thread G	Pressure range bar	Order number
A	B	C		m³/h*1	l/min*1			

Precision pressure regulator								supply pressure max. 16 bar, relieving, with constant bleed	R03
82	200	41	2.1	198	3300	G¼*3	0.01 ... 3	R03-02A	
							0.02 ... 5	R03-02B	
							0.04 ... 7	R03-02C	
							0.05 ... 10	R03-02D	
82	200	41	2.4	228	3800	G¾*3	0.01 ... 3	R03-03A	
							0.02 ... 5	R03-03B	
							0.04 ... 7	R03-03C	
							0.05 ... 10	R03-03D	
82	200	41	2.9	270	4500	G½	0.01 ... 3	R03-04A	
							0.02 ... 5	R03-04B	
							0.04 ... 7	R03-04C	
							0.05 ... 10	R03-04D	



R03

## Special options, add the appropriate letter

**tamper-proof cap** total height 204 mm R03-0..T

## Accessories, enclosed

**pressure gauge** Ø 50 mm, 0...\*2 bar, G¼ **MA5002-...\*2**  
**mounting bracket** made of steel **BW00-36**

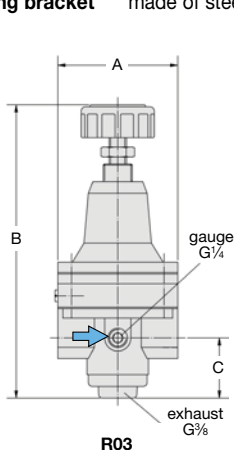

R03

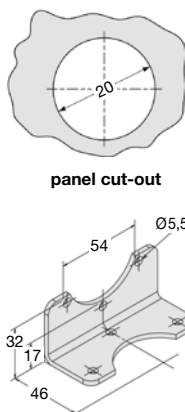

panel cut-out

BW00-36

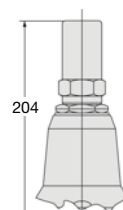

tamper-proof cap

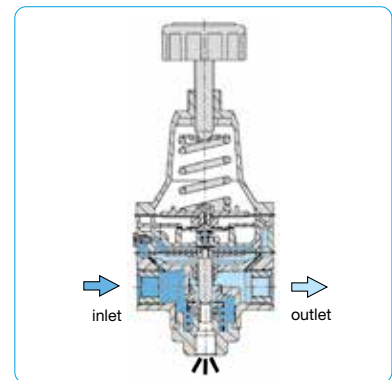

cross-section

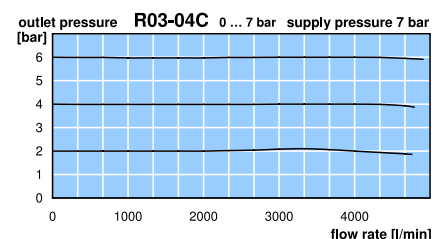
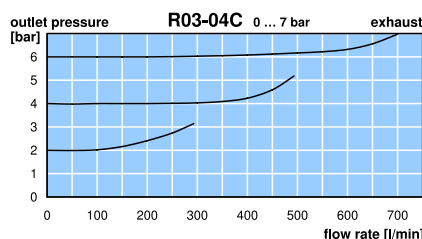
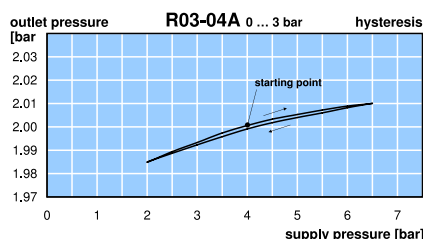

\*1 at 7 bar supply pressure and 6 bar outlet pressure  
 \*2 04 = 0...4 bar, 06 = 0...6 bar, 10 = 0...10 bar

\*3 standard unit G½ is reduced to smaller threads by fittings

Gauges: see chapter for measuring devices

PDF CAD  
www.aircom.net

Order example:  
R03-02A

<b>Description</b>	Diaphragm regulator with small dimensions. Suitable for low pressure applications, with high relief capacity. A sensitive rolling diaphragm ensure constant outlet pressure even with changing supply pressure and flow fluctuations.	
<b>Media</b>	compressed air or non-corrosive gases	
<b>Recommendation</b>	connection thread G $\frac{1}{2}$ for pressure range 0...35 / 140 / 280 mbar	
<b>Supply pressure</b>	max. 10 bar	
<b>Accuracy</b>	response sensitivity: < 0,2 mbar	<b>Air consumption</b> max. 2 l/min depending on outlet pressure
<b>Adjustment</b>	by handwheel with locknut	
<b>Relieving function</b>	relieving, optionally non-relieving	<b>Relief capacity</b> 14 l/min at 7 mbar above setpoint 70 mbar
<b>Gauge port</b>	G $\frac{1}{4}$ on both sides of the body, optionally $\frac{1}{4}$ NPT	
<b>Mounting position</b>	any	
<b>Temperature range</b>	0 °C to 90 °C / 32 °F to 194 °F, for appropriately conditioned compressed air down to -40 °C / -40 °F	
<b>Material</b>	Bod<: aluminium die-cast Inner valve: stainless steel and galvanised steel Elastomer: NBR/Buna-N, optionally FKM	

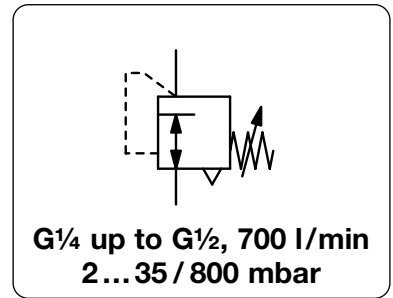

Dimensions			K <sub>v</sub> -value (m <sup>3</sup> /h)	Flow rate		Connection thread G	Pressure range mbar	Order number
A	B	C		m <sup>3</sup> /h*1	l/min*1			

Precision regulator for low pressure							supply pressure max. 10 bar, relieving, with constant bleed	<b>R110</b>
67	180	25	0,4	42	700	G $\frac{1}{4}$	2... 35	<b>R110-020</b>
							2... 140	<b>R110-02A</b>
							2... 280	<b>R110-02B</b>
							2... 400	<b>R110-02C</b>
							2... 800	<b>R110-02D</b>
67	180	25	0,4	42	700	G $\frac{1}{2}$	2... 35	<b>R110-040</b>
							2... 140	<b>R110-04A</b>
							2... 280	<b>R110-04B</b>
							2... 400	<b>R110-04C</b>
							2... 800	<b>R110-04D</b>



R110

Special options, add the appropriate letter		
<b>G<math>\frac{3}{8}</math></b>	connection thread	R110-03 .
<b>NPT</b>	connection thread	R110-0 . .N
<b>non-relieving</b>	without constant bleed	R110-0 . .K
<b>reduced bleeding</b>	ca. 1 l/min	R110-0 . .X19
<b>tapped exhaust</b>	connection thread G $\frac{1}{4}$	R110-0 . .X12
<b>FKM elastomer</b>		R110-0 . .V
<b>tamper-proof cap</b>	aluminium, adjustment by screwdriver, total height 183 mm	R110-0 . .T

Accessories, enclosed		
<b>pressure gauge</b>	Ø 63 mm, 0... *2 mbar, G $\frac{1}{4}$ , capsule type	<b>MA6302-... *2</b>
	Ø 63 mm, 0...600mbar, G $\frac{1}{4}$ , Bourdon tube	<b>MA6302-C6</b>
	Ø 63 mm, 0... 1 bar, G $\frac{1}{4}$ , Bourdon tube	<b>MA6302-01</b>
<b>gauge connectors</b>	NPT connection thread, adapter $\frac{1}{4}$ " NPT to G $\frac{1}{4}$ female	<b>VP-0202N</b>
<b>mounting bracket</b>	made of steel	<b>BW00-58</b>

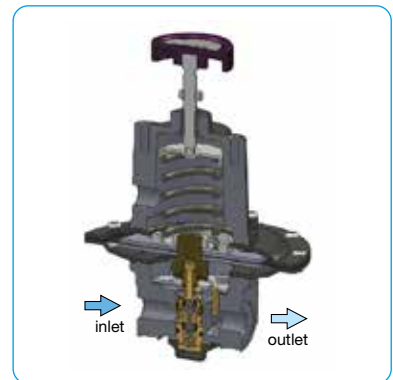

cross-section

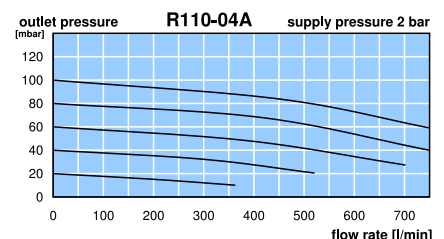
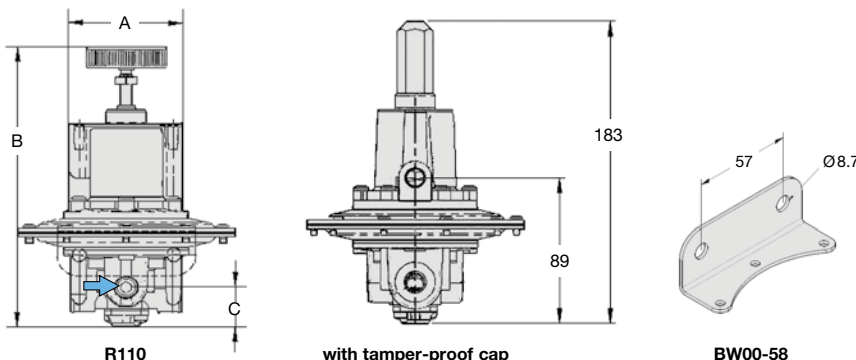

\*1 at 7 bar supply pressure, 800 mbar outlet pressure and 40 mbar pressure drop  
\*2 B6 = 0...60 mbar, C2 = 0...160 mbar, C3 = 0...250 mbar, C4 = 0...400 mbar

# PRECISION REGULATOR WITHOUT CONSTANT BLEED, UP TO 16 BAR OUTLET PRESSURE R217

<b>Description</b>	Diaphragm pressure regulator with good regulation accuracy at varying volume flow.		
<b>Media</b>	compressed air or non-corrosive gases		
<b>Supply pressure</b>	max. 16 bar		
<b>Accuracy</b>	response sensitivity: < 350 mbar		
<b>Air consumption</b>	without constant bleed		
<b>Adjustment</b>	by handwheel with locknut, suitable for panel mounting		
<b>Relieving function</b>	relieving		
<b>Gauge port</b>	G $\frac{1}{4}$ on both sides of the body, one screw plug supplied		
<b>Mounting position</b>	any		
<b>Temperature range</b>	0 °C to 80 °C / 32 °F to 176 °F		
<b>Material</b>	Body: zinc die-cast	O-ring: NBR/Buna-N	
	Spring cage: zinc die-cast	Bottom screw: POM	
	Diaphragm: FKM		

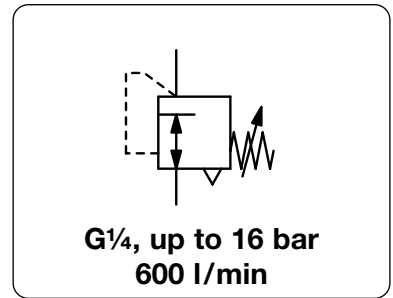

Dimensions			K <sub>v</sub> -value (m <sup>3</sup> /h)	Flow rate m <sup>3</sup> /h*1 l/min*1	Connection thread G	Pressure range bar	Order number
A	B	C					

Precision pressure regulator							supply pressure max. 16 bar, relieving, without constant bleed	R217
82	148	20	0,3	36	600	G $\frac{1}{4}$	0,01 ... 0,5	R217-020
							0,01 ... 1	R217-02A
							0,20 ... 3	R217-02B
							0,40 ... 6	R217-02C
							0,50 ... 10	R217-02D
							0,70 ... 16	R217-02E

**Special options, add the appropriate letter**

free of grease and oil specially cleaned R217-0..L



**Accessories, enclosed**

pressure gauge Ø 63 mm, 0...\*2 bar, G $\frac{1}{4}$  MA6302-...\*2

mounting bracket made of steel BW00-36

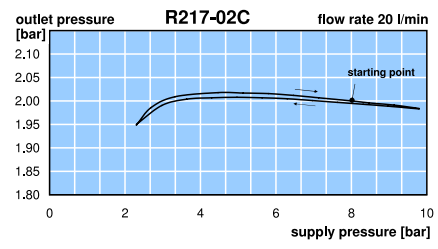
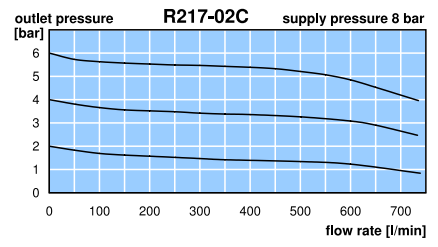
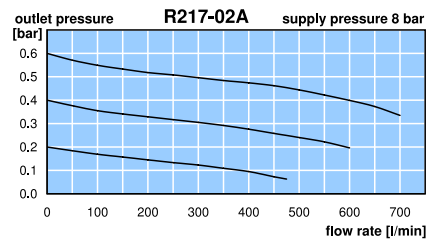
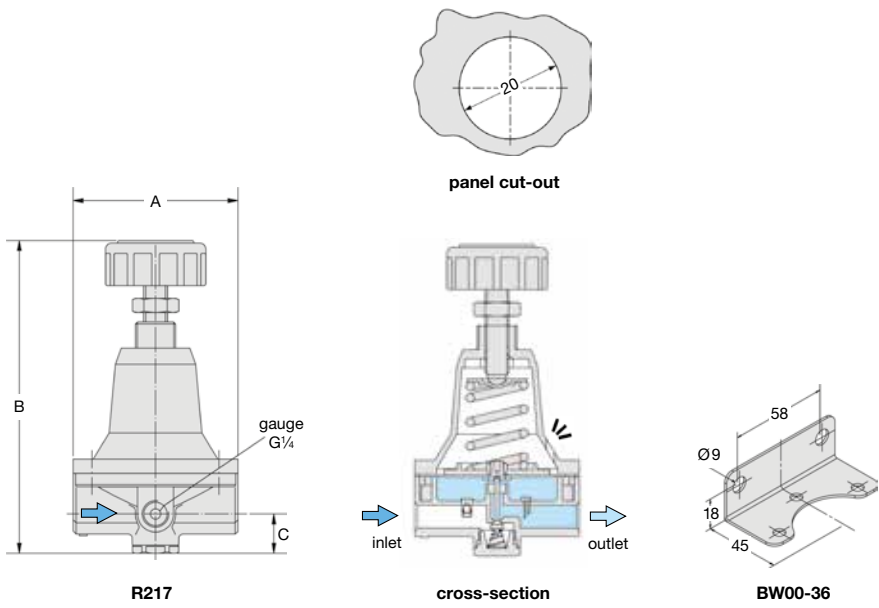
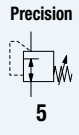

\*1 at 8 bar supply pressure, 6 bar outlet pressure und 1 bar pressure drop  
\*2 01 = 0...1 bar, 04 = 0...4 bar, 06 = 0...6 bar, 10 = 0...10 bar, 16 = 0...16 bar

R700

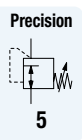

# R410

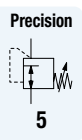

# PRECISION PRESSURE REGULATOR WITHOUT CONSTANT BLEED

R400

<b>Description</b>	The diaphragm regulator provides high-precision regulation in high flow and high relief applications. A sensitive rolling diaphragm and balanced inner valve ensure constant outlet pressure even with changing supply pressure and flow fluctuations.	
<b>Media</b>	compressed air or non-corrosive gases	
<b>Supply pressure</b>	max. 18 bar	
<b>Accuracy</b>	response sensitivity: < 2 mbar	
<b>Air consumption</b>	without constant bleed	
<b>Adjustment</b>	by handwheel with locknut	
<b>Relieving function</b>	relieving	
<b>Relief capacity</b>	1000 l/min at 1.5 bar outlet and 0.35 bar overpressure above setpoint	
<b>Gauge port</b>	G $\frac{1}{4}$ on both sides of the body, screw plugs supplied	
<b>Temperature range</b>	0 °C to 90 °C / 32 °F to 194 °F, for appropriately conditioned compressed air down to -40 °C / -40 °F	
<b>Material</b>	Body: aluminium die-cast	Elastomer: NBR/Buna-N, optionally FKM
	Inner valve: stainless steel, brass, aluminium and steel	

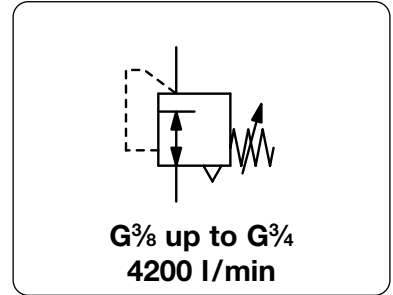

Dimensions			K <sub>v</sub> -value (m <sup>3</sup> /h)	Flow rate		Connection thread G	Pressure range bar	Order number
A	B	C		m <sup>3</sup> /h*1	l/min*1			

Precision pressure regulator							supply pressure max. 18 bar, relieving, without constant bleed	R400
89	206	39	2.12	228	3800	G $\frac{3}{8}$	0.03 ... 0.7	R400-031
							0.03 ... 2.0	R400-03A
							0.07 ... 4.0	R400-03B
							0.15 ... 10	R400-03C
							0.35 ... 17	R400-03D
89	206	39	2.23	240	4000	G $\frac{1}{2}$	0.03 ... 0.7	R400-041
							0.03 ... 2.0	R400-04A
							0.07 ... 4.0	R400-04B
							0.15 ... 10	R400-04C
							0.35 ... 17	R400-04D
89	206	39	2.34	252	4200	G $\frac{3}{4}$	0.03 ... 0.7	R400-061
							0.03 ... 2.0	R400-06A
							0.07 ... 4.0	R400-06B
							0.15 ... 10	R400-06C
							0.35 ... 17	R400-06D



R400

## Special options, add the appropriate letter

tapped exhaust	connection thread G $\frac{1}{4}$	R400-0 . . X12
NPT	connection thread	R400-0 . . N
tamper-proof cap	of aluminium, adjustment by screwdriver, total height 295 mm	R400-0 . . T
FKM elastomer	up to 10 bar	R400-0 . . V

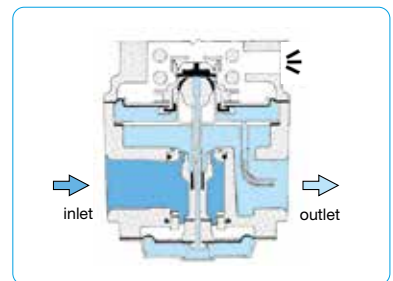

cross-section

## Accessories, enclosed

pressure gauge	Ø 63 mm, 0...*2 bar, G $\frac{1}{4}$	MA6302-...*2
mounting bracket	made of steel	BW00-47

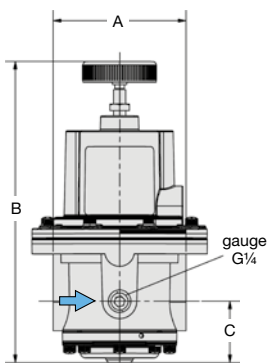

R400

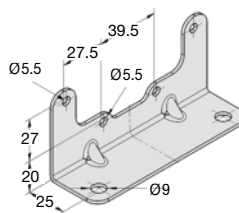

BW00-47

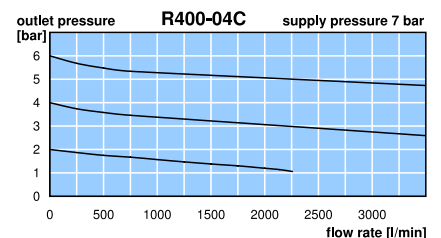
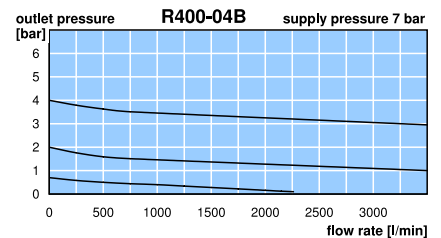

<b>Description</b>	Provides precision regulation in high flow and high relief applications. A sensitive rolling diaphragm and balanced inner valve assure constant outlet pressure even with supply pressure and flow fluctuations.	
<b>Media</b>	compressed air or non-corrosive gases	
<b>Supply pressure</b>	max. 18 bar, optionally max. 35 bar	
<b>Accuracy</b>	response sensitivity: < 2 mbar	
<b>Air consumption</b>	0.5% of volume flow, max. 15 l/min	
<b>Adjustment</b>	by T-handle with locknut	
<b>Relieving function</b>	relieving, optionally non-relieving	
<b>Relief capacity</b>	1200 l/min at 1.5 bar outlet and 0.35 bar overpressure above setpoint	
<b>Gauge port</b>	G¼ for outlet pressure	<b>Mounting position</b> any
<b>Temperature range</b>	0 °C to 90 °C / 32 °F to 194 °F, for appropriately conditioned compressed air down to -40 °C / -40 °F	
<b>Material</b>	Body: aluminium die-cast Elastomer: NBR/Buna-N, optionally FKM at 35 bar version Inner valve: stainless steel, brass, aluminium and steel	

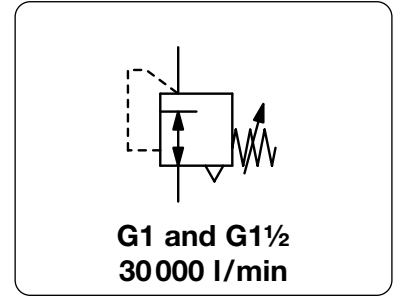

Dimensions			K <sub>v</sub> -value (m³/h)	Flow rate m³/h*1 l/min*1	Connection thread G	Pressure range bar	Order number
A	B	C					

Precision pressure regulator							supply pressure max. 18 bar, relieving, with constant bleed	R102
141	287	56	11.4	1680	28000	G1	0.001 ... 0.7	R102-081
							0.03 ... 2.0	R102-08A
							0.07 ... 4.0	R102-08B
							0.14 ... 7.0	R102-08C
							0.14 ... 10	R102-08D
141	287	56	12.2	1800	30000	G1½	0.001 ... 0.7	R102-121
							0.03 ... 2.0	R102-12A
							0.07 ... 4.0	R102-12B
							0.14 ... 7.0	R102-12C
							0.14 ... 10	R102-12D



**Special options,** add the appropriate letter

<b>NPT</b>	connection thread	R102-... N
<b>non-relieving</b>	and without constant bleed	R102-... K
<b>supply pressure 35 bar</b>	free of non-ferrous metal, FKM elastomer	R102-... X62
<b>tamper-proof cap</b>	aluminium, adjustment by screwdriver, total height 295 mm	R102-... T

**Accessories,** enclosed

<b>pressure gauge</b>	Ø 63 mm, 0...*2 bar, G¼	MA6302-...*2
<b>mounting bracket</b>	made of steel	BW00-30

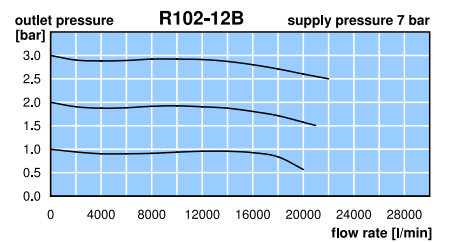
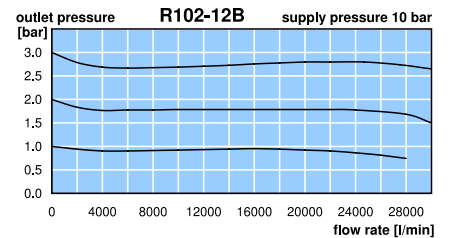
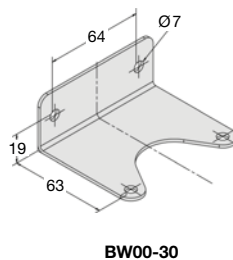
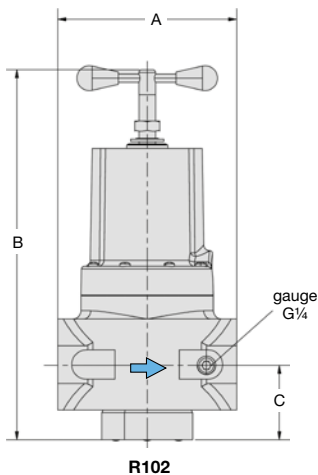
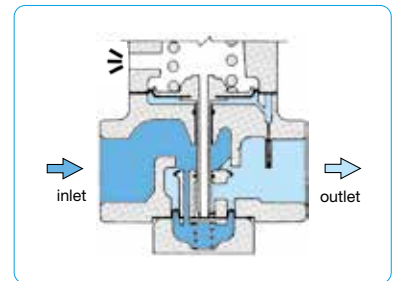

\*1 at 10 bar supply pressure and 2.8 bar outlet pressure  
\*2 01 = 0...1 bar, 02 = 0...2.5 bar, 04 = 0...4 bar, 10 = 0...10 bar